

# Multichannel High Power Transmitter

869 MHZ FSK HIGH POWER 500 mW

## TX 869 BOOST

Part Number: 650201088G

### DESCRIZIONE

Modulo trasmettitore multicanale FSK con antenna esterna per applicazioni di trasmissione di dati digitali a lunga distanza. Conforme CEPT 70-03 Annesso 1 43

### APPLICATIONS

- ▣ Localizzazione animali
- ▣ Irrigazione giardini
- ▣ Telesoccorso
- ▣ Segnaletica stradale temporanea
- ▣ Telemetria ambientale

### DESCRIPTION

Multichannel FSK transmitter module with external antenna ideal for applications of long range digital data transmission. Compliant to CEPT 70-03 Annex 1 43

### APPLICATIONS

- ▣ Animal Tracking
- ▣ Garden Irrigation
- ▣ Rescue
- ▣ Road works lighting
- ▣ Environment telemetry

### TECHNICAL SPECIFICATION

Ta = 25 °C

CHARACTERISTICS	CARATTERISTICHE	MIN	TYP	MAX	UNIT
Supply voltage	Alimentazione	3	5	5.5	Vdc
Supply current	Corrente assorbita		420	480	mA
Supply current (STAND BY)	Corrente assorbita (STAND BY)		0.3	1	µA
Working frequency (4 CH)	Frequenza di lavoro (4 CANALI)		869.45 - 869.60		MHz
RF output power	Potenza in uscita RF	+24	+27		dBm
RF output impedance	Impedenza di uscita RF		50		Ohm
Output high voltage (DATA IN)	Livello alto d'uscita (DATA IN)	2.8		5.5	V
Output low voltage	Livello basso d'uscita			0.1	V
Data rate Manchester	Data rate Manchester	0.5		19.2	Kbps
Operating temperature range	Temperatura di lavoro	-20		+80	°C

### DIMENSIONS

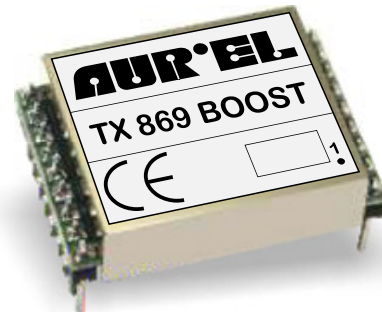

### COMPONENT SIDE

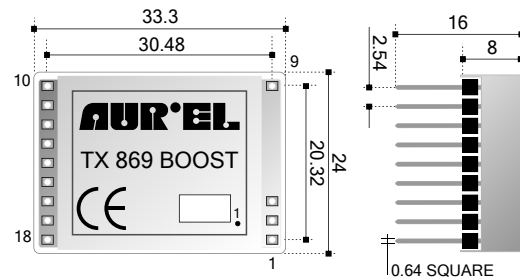

### PIN-OUT

- |            |                 |
|------------|-----------------|
| 1) GND RF  | 13) AUX IN (NC) |
| 2) ANT     | 14) DATA IN     |
| 3) GND RF  | 15) PA-CTRL     |
| 9) GND     | 16) ENABLE      |
| 10) GND    | 17) VCC         |
| 11) FSEL 0 | 18) GND         |
| 12) FSEL 1 |                 |

## TX 869 BOOST 500 mW (+27dBm) Multichannel High Power TX

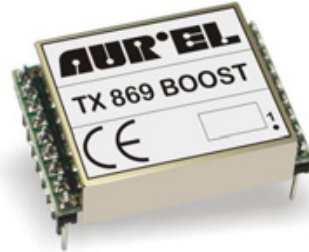

TX 869 0,5 Watt is a multichannel FSK transmitter module operating in the ISM band, 869.4 - 869.65 MHz with external antenna for transmission of digital data cover long distances, according to Decision 2006/771/EC of the European Union for use in time of 10 % measured on an hourly basis.

Ideal for radio links, high distance, free from government concessions

Very low power consumption in stand-by (< 1uA), very fast wake-up and possibility of external regulation of the wanted power, ideal for battery powered systems.

Conforms to European EN300 220 and EN300 489

### Main Features

- Very low consumption in power down (<1uA)
- Low price
- Sistema quarzato a sintesi PLL
- Multichannel RF
- Reduced dimension (33 x 24 mm)
- Bit rate max 19.200 bps
- Emitted power: max 500 mW (+27dBm)
- Power supply from 3 to 5 Volt

### Applicazioni

- Irrigation Systems
- Animal Tracking
- Environment Telemetry
- Road Works Lighting
- Long Distance Data Collection
- Rescue localization
- Telealarms

## Absolute Limits

Operating temperature	-20 °C ÷ +85 °C
Storage temperature	-40 °C ÷ +100 °C
Power supply	-0,3V +5,5V
Input voltage	-0,3V÷VCC+0,3V
Output voltage	-0,3V÷VCC+0,3V

**Note: In order to obtain claimed performance avoiding disturbs due the high power emitted from the module, must be carefully performed as reported in this manual.**

Technical features are subject to change without notice. AUR<sup>®</sup>EL S.p.A does not assume responsibilities for any damage caused by the device's misuse..

## Technical Features

	Min.	Tip.	Max.	Unit
<b>DC Levels</b>				
Supply voltage Vcc pin.17	3,0	5	5,5	V
Power consumption (PA active)		420	480	mA
Power consumption in <b>Ton</b> (coupling awaiting)		25,0	35,0	mA
Power consumption (stand-by mode)		0,3	1	μA
Switch-on time <b>Ton</b>		100	110	msec
Switch-off time <b>Toff</b>		30		msec
Logic level "1" input pins 14 and 16	2,8		5,5	V
Logic level "1" input pins 11 and 12			2,8	V
Logic level "0" input pins 11-12-14-16			0,1 x Vcc	V
<b>Transmitter</b>				
Frequency Band CH 1		869,45		MHz
Frequency Band CH 2		869,50		MHz
Frequency Band CH 3		869,55		MHz
Frequency Band CH 4		869,60		MHz
Modulation	FSK			
RF output power Measured on Antenna PIN with 50ohm load		+27	+29	dBm
Spurious <1GHz Measured on Antenna PIN with 50ohm load			-36	dBm
Spurious from 1GHz to 4GHz Measured on Antenna PIN with 50ohm load			-30	dBm
Data-rate Manchester	0,5		19,2	Kbps

## Block diagram

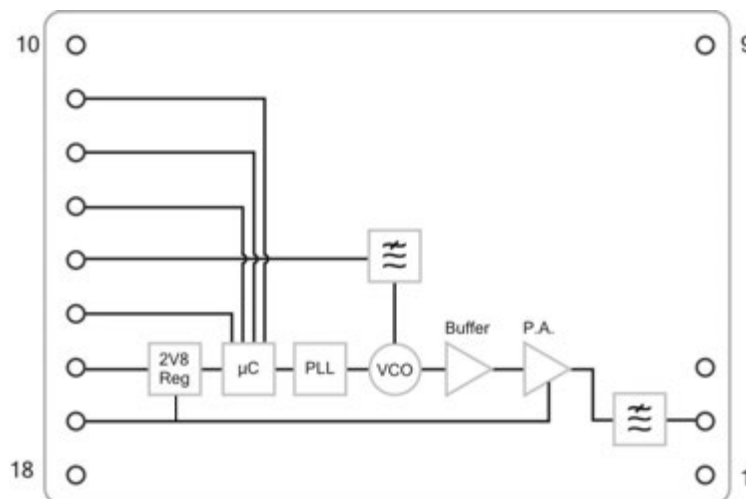

**Fig. 1** – TX Block diagram

Technical features are subject to change without notice. AUR<sup>®</sup>EL S.p.A does not assume responsibilities for any damage caused by the device's misuse..

**Pins description and mechanical dimensions**

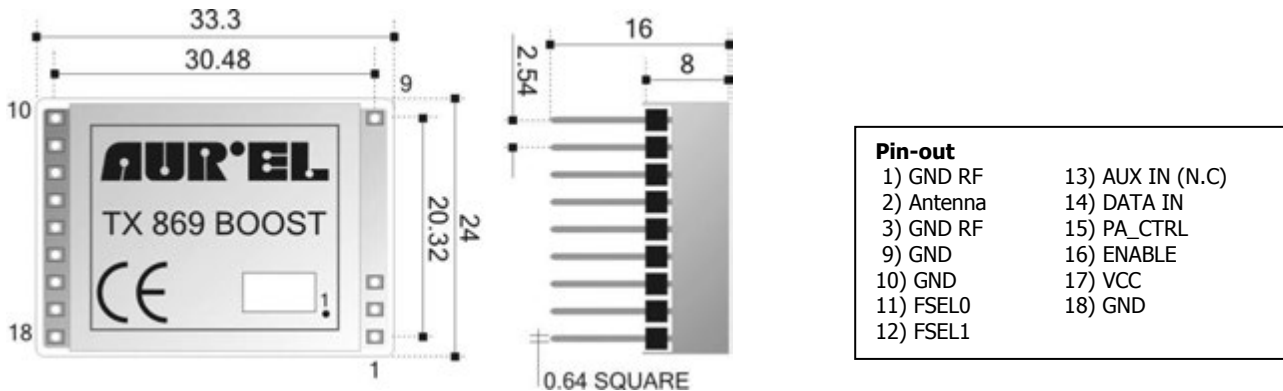

**Fig. 2** – Module mechanical dimensions

Pin n°	Name	Description
1 - 3	<b>GND RF</b>	Connection with RF ground plane
2	<b>Antenna</b>	Antenna connection, 50 ohm impedance. RF TX output
9 - 10	<b>GND</b>	Connection to ground plane
11	<b>Fsel0</b>	Transmission Frequency selection. Active when low (internal pull-up )
12	<b>Fsel1</b>	Transmission Frequency selection. Active when high (internal pull-up )
13	<b>NC</b>	Reserved (connected to internal uC for custom application)
14	<b>Data In</b>	Digital data input. 0-5,5V max with 10Kohm load
15	<b>PA_CTRL</b>	Analog input of output power regulation. (see fig.4) Pin 15 = Not Connected (max. power output on antenna) Pin 15 = GND (min. power output on antenna)
16	<b>Enable</b>	Connect to positive or negative of power supply as follow: 0 = PWDN (device off consumption max. 1uA) 1 = Active (device on)
17	<b>Vcc</b>	Device power supply
18	<b>GND</b>	Connection to ground plane

**Tab. 1** – Pins description

**Operation description**

This module, is a FSK HIGH POWER Transmitter operates in a harmonized frequency band ISM 869,4 – 869,65MHz, realized with a frequency synthesizer circuit, low noise VCO, and heavy-duty power circuit able to deliver +28 dBm a 5V e +24dBm on 3V.

Transmitter use a frequency synthesis circuit with RF channel selecting in a very easy way, through connect to GND 11 and 12 pin.

**NOTE: It is strongly recommended to connect pins 11-12 ONLY to GND, pull-up internal resistances are connected to +2,8V; then the pins 11 and 12 can not be connected to a voltage greater than 3.0 V max.**

Technical features are subject to change without notice. AUREL S.p.A does not assume responsibilities for any damage caused by the device's misuse..

Frequency value (MHz)	Pin 11	Pin 12
869,45	0	0
869,50	NC	0
869,55	0	NC
869,60	NC	NC

**Tab. 2** – Selected frequency values

After setting the value of the frequency by pins 11 and 12, procedure for giving effect to the change of channel foreseen the ENABLE pin (16) must be brought to prevede che il pin di ENABLE (16) to a low logic level and then to logic level high, while respecting the timing declared. This transition allows to switch-on the transmitter.

Ton is the time needed to set ready the TX for data transmission fitted in 100msec about.

From logic level High to logic level low allows to switch-off the module.

Toff is the time needed to set in power down the TX and it's fitted in 30msec about.

Look at fig.3 that explain temporal trends of ENABLE pin and DATA IN

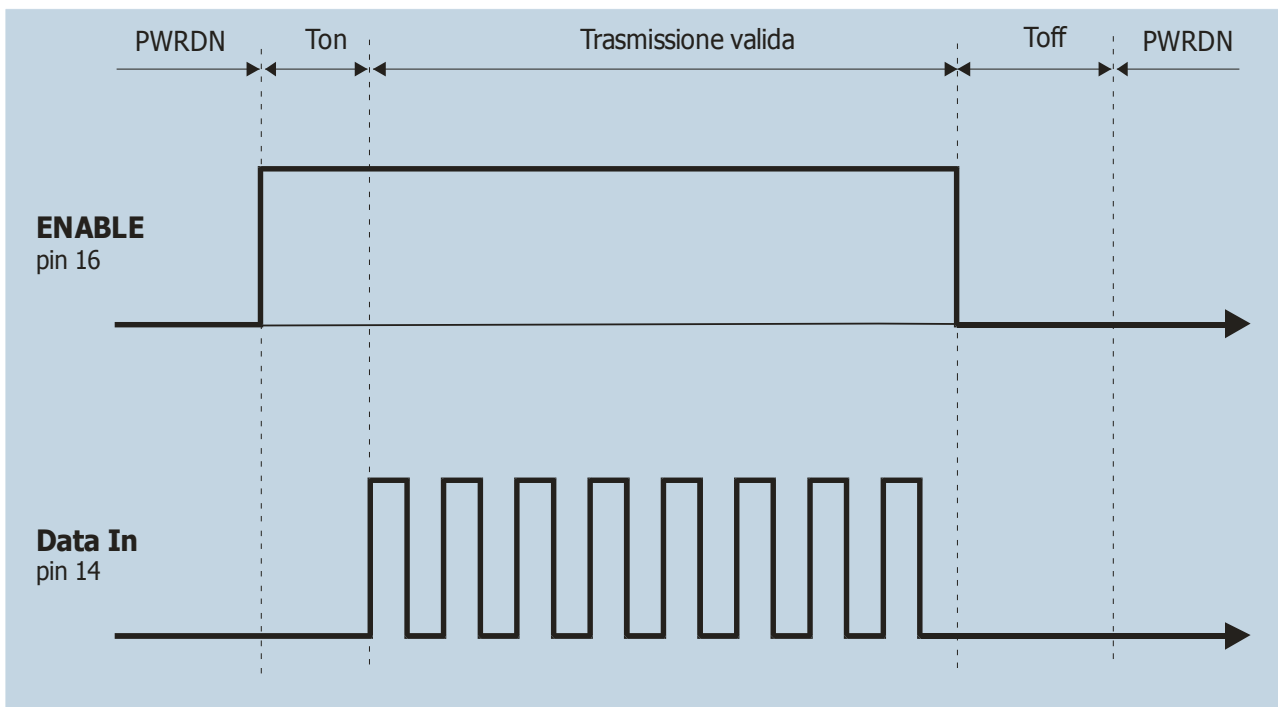

**Fig. 3** - SWITCH-ON and SWITCH-OFF timing.

### Output RF power regulation

Pin 15 named PA\_CTRL gives the regulation of the Emitted RF power from antenna. This can be used in case full power is not needed and a reduction of current consumption from power supply is needed (see fig.5). Furthermore this setting could be of advantage to be in compliance with normative when an High gain antenna is used. RV could be also a changeable resistance. In order to apply this function please see fig.4

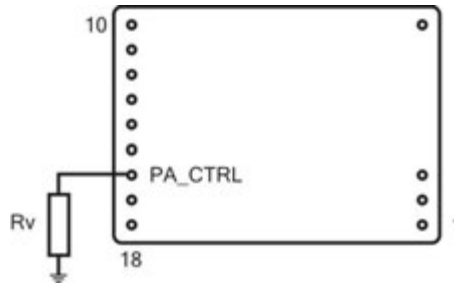

**Fig. 4** – Resistance connecting drawing for power control

Through a resistor of appropriate value, is obtained a supply voltage variation to the pin 15 PA\_CTRL. Allows to operate on output power value (fig.6)

permette di agire sul valore della potenza di uscita (figura 6), consequently there is also a change in current consumption (fig.5).

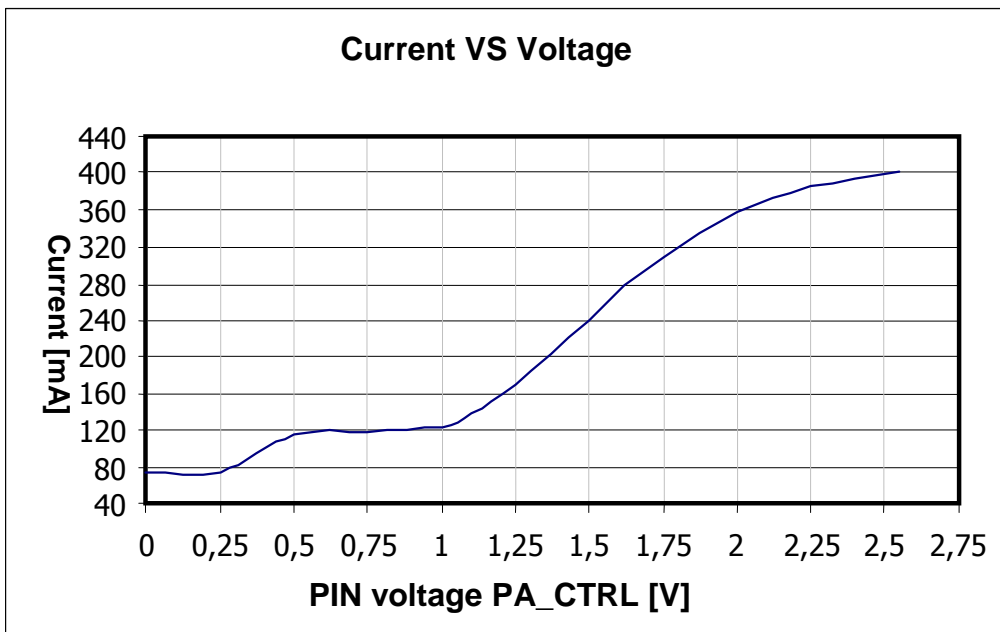

**Fig. 5**

Technical features are subject to change without notice. AUR°EL S.p.A does not assume responsibilities for any damage caused by the device's misuse..

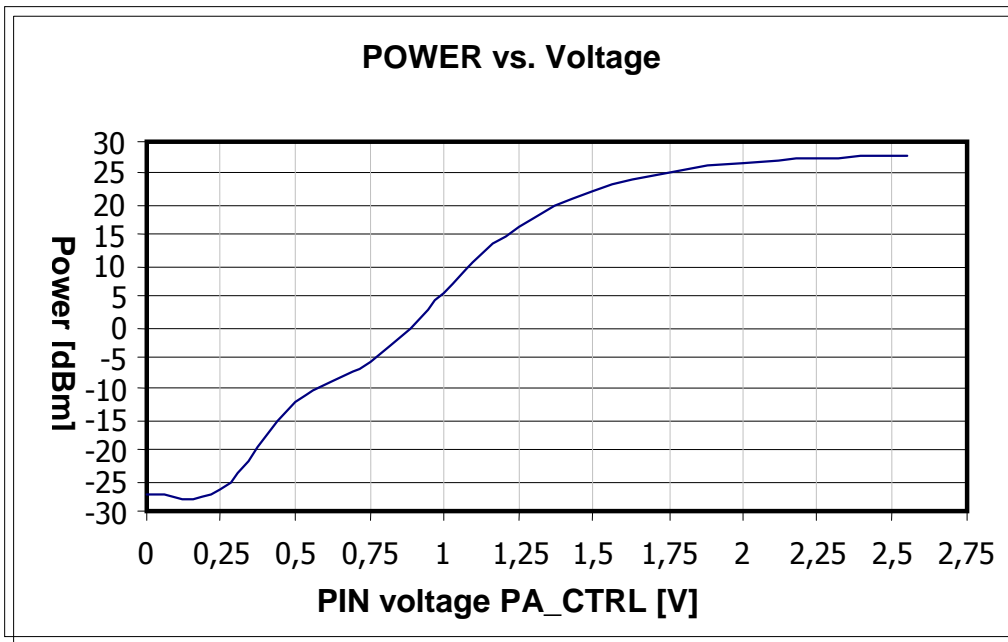

Fig. 6

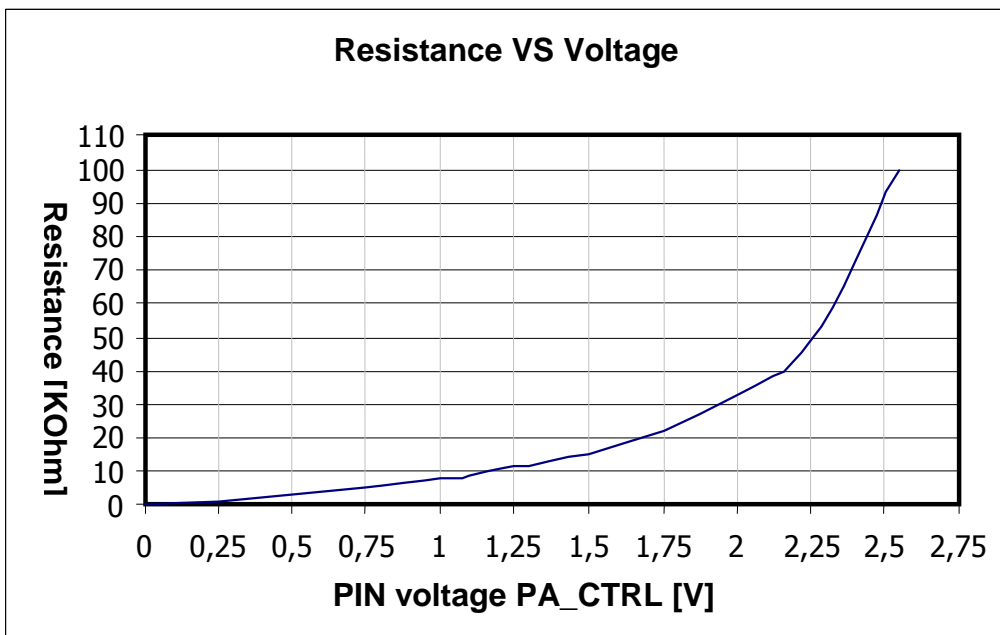

Fig. 7

Values have been obtained by applying test temperature at 25°C and maximum 5V power supply.

Technical features are subject to change without notice. AUR°EL S.p.A does not assume responsibilities for any damage caused by the device's misuse..

## Output power features

In Fig.8 is reported trend of Rf output power in reference to the Supply Voltage applied, whereas in Fig.9 is reported trend of Power consumption in function of the Supply voltage. Values have been obtained by applying test temperature at 25°C

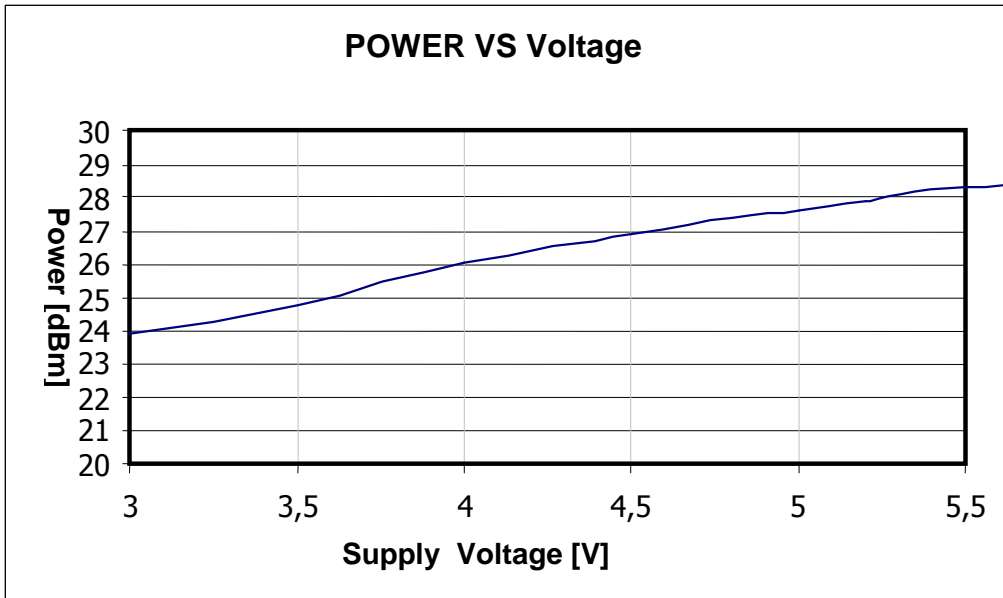
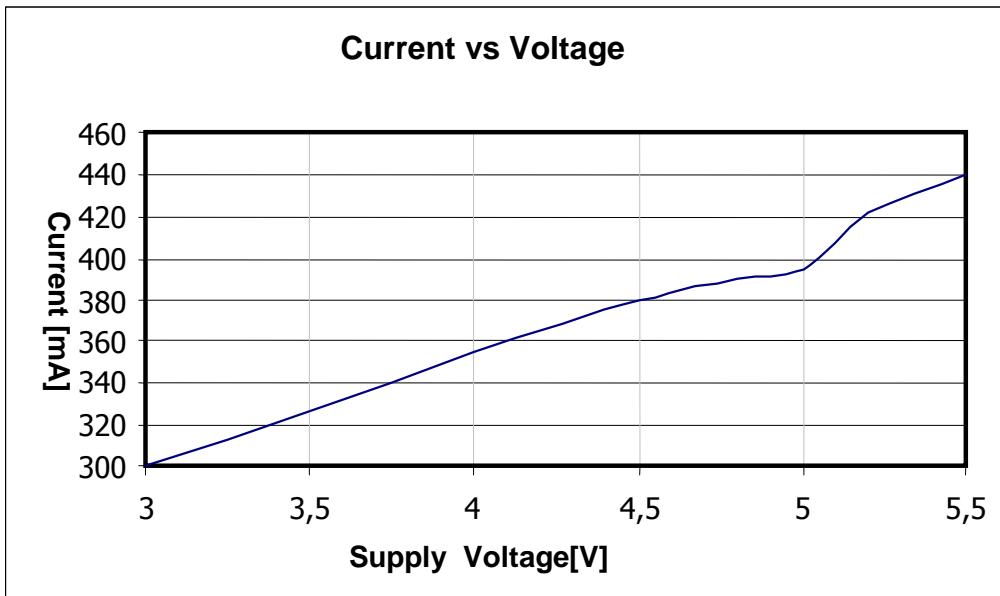
**Fig. 8****Fig. 9**

Technical features are subject to change without notice. AUR°EL S.p.A does not assume responsibilities for any damage caused by the device's misuse..



### Module Supply Voltage

Supply Voltage of TX 869 500mW, Pin 17, must be filtered using a large capacitor 330-1.000uF, capable of delivering energy despite of peaks of current that can reach 450mA

L'alimentazione del, pin 17, deve essere opportunamente filtrata mediante l'utilizzo di un grosso condensatore 330-1.000uF, in grado di erogare energia nei picchi di corrente che possono raggiungere i 450mA. Below is presented an application example, where the voltage regulator in 3 Volt fuels the microcontroller to manage the TX 869 Boost

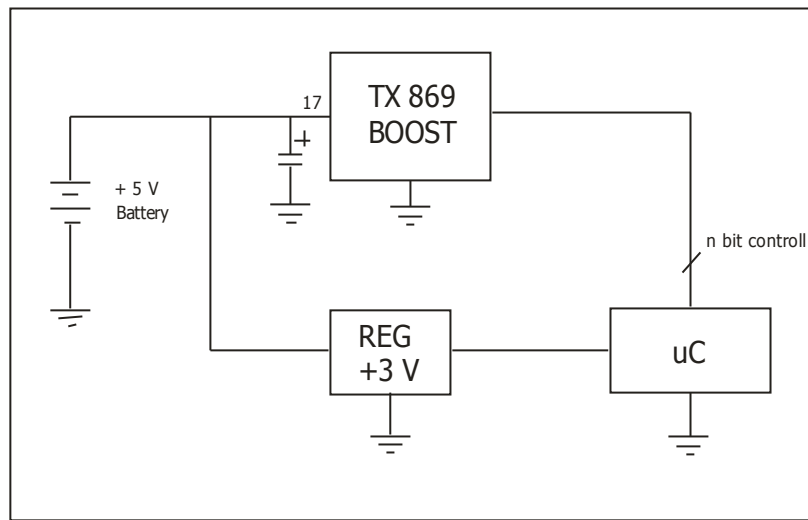

**Fig. 10** – Module supply and interfacing with uC

Final application always needs to keep separate Power Supply circuit from the rest circuit that will be powered by a voltage regulator of 3V

Modulating signal gate is a digital data input, and it's allows 0-Vcc signals with tension limits of 0-3V, useful in case of uC powered at 3V manage such modulation.

The transmitter provides data transmission included in max 500us and min. 50us

Transmitted data must be always encoded, as an encoding as Manchester, whatever data packet must be imperatively preceded by a preamble made by a square wave signal with a a Tp duration at least of 10mS

Time-diagram shows a typical modulating-signal consisting of a preamble and data:

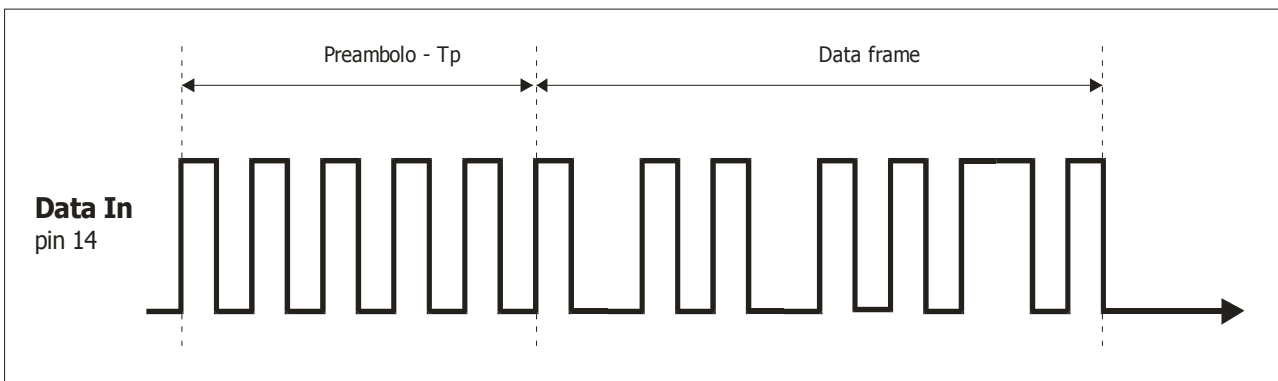

**Fig. 11** – Manchester encoding

## Device usage

In order to obtain the performances described in the technical specifications and to comply with the operating conditions, which characterize the Certification, the transmitter has to be mounted on a printed circuit, and keep into consideration what follows:

### Voltage supply:

1. The transmitter must be supplied by a very low voltage source, safely protected against short circuits. Maximum voltage variations allowed:  $2,5 \div 3,3V$ .
2. De-coupling, next to the transmitter, by means of a minimum 100.000 pF ceramic capacitor
3. Capacitor  $330 \div 1000\mu F$  connected between pin 17 and ground plane, located next to the pin 17.

### Ground Plane

It must surround at the best the welding area of the transmitter. The circuit must be double layer, with throughout vias to the ground planes.

Furthermore, on ground plane where is placed the module, and at the edge of the screen, it is essential to open the solder-resist in order to assure many welding points that made fully shielded the module and shall not be present others opening from others tracks

### Connection between antenna and pin 3:

1. 2,7 mm wide for 1,6 mm thick FR4 printed circuits and 1,6mm wide for 1mm thick FR4 printed circuits. On the same side, it must be kept 2 mm away from the ground circuit.
2. On the opposite side a ground circuit area must be present.

### Antenna:

A **whip** antenna, 8,50 mm long and approximately 0,5 mm dia., brass or copper wire made, must be connected to the RF input of the transceiver.

The antenna body must be keep as much as possible straight and it must be free from other circuits or metal parts (5 cm minimum suggested distance.). Others antenna (coiled, turned down) can be accepted but performances are reduced and there is not the guarantee to pass the normatives.

### Other components:

1. Keep the transmitter separate from all other components of the circuit (more than 5 mm).
2. Keep particularly far away and shielded all microprocessors and their clock circuits.
3. Do not fit components around antenna connection and ground plane. Keep them at least at 5 mm distance.

## Reference Rules

The **XTR-869** transceiver is CE certified and in particular it complies with the European Rules **EN 300 220**, and **EN 301 489**. The equipment has been tested according to rule EN 60950 and it can be utilized inside a special insulated housing that assures the compliance with the above-mentioned rule. The transceiver must be supplied by a very low voltage safety source protected against short circuits

The use of the transceiver module is foreseen inside housings that assure the overcoming of the Rule **EN 61000-4-3** not directly applicable to the module itself. In particular, it is at the user's care the insulation of the external antenna connection, and of the antenna itself since the RF output of the receiver is not built to directly bear the electrostatic charges foreseen by the a.m. rule.